

ME - 4141

Instruções de Montagem Assembly Instructions Instrucciones de Montaje

Notas Especiais:

01 - Examine completamente todas as peças do móvel antes de começar o trabalho.

02 - Recomenda-se montar o móvel conforme este Manual de Montagem.

03 - É de responsabilidade do montador seguir as instruções do Manual de Montagem, que são fundamentais para garantir a estrutura do móvel.

04 - Para limpeza, utilizar somente pano úmido e sabão neutro.

Special notes:

01 - Check all parts of the unit thoroughly before starting work.

02 - It is recommended to assemble the furniture according to this Installation Manual.

03 - It is the responsibility of the assembler to follow the instructions in the Assembly Manual, which are essential to ensure the structure of the furniture.

04 - For cleaning use only damp cloth and neutral soap.

Notas especiales:

01 - Examine completamente todas las piezas del mueble antes de iniciar el trabajo.

02 - Se recomienda montar el mueble conforme el Manual de Ensamblaje.

03 - Es de responsabilidad del montador seguir las instrucciones del Manual de Ensamblaje, que son fundamentales para garantizar la estructura del mueble.

04 - Para limpieza solamente usar trapo húmedo y jabón neutro.

Garante certificate:

The guarantee of products manufactured by Móveis Videira LTDA covers any defects / manufacturing defects, within the period established by the Consumer Protection Code, in its Article 26, II, which provides for a legal guarantee of ninety (90) days.

Ferramentas | Tools | Herramientas

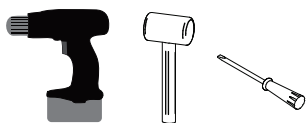







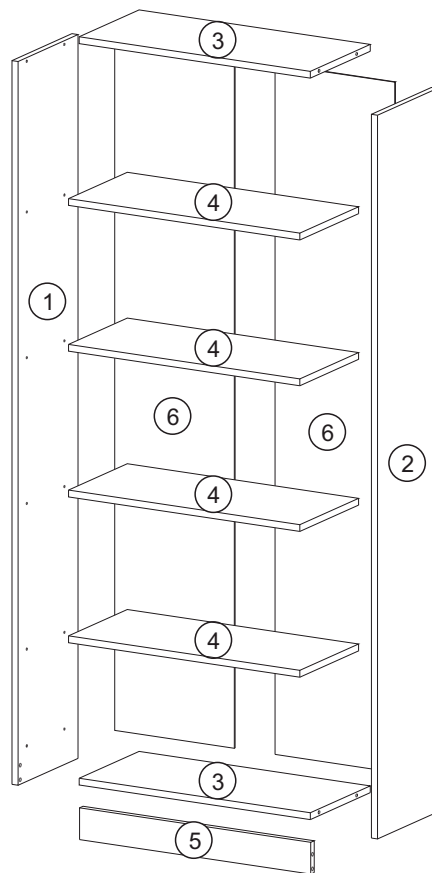

45 min.



Lista de Peças / List of pieces / Lista de piezas

CÓD	DESCRIÇÃO	DESCRIPTION	DESCRIPCIÓN	QTD	RAW MATERIAL	DIMENSION
01	Lateral Esquerda	Left Side	Lateral Izquierda	1	MDP 15mm	1594x255x15
02	Lateral Direita	Right Side	Lateral Derecha	1	MDP 15mm	1594x255x15
03	Base	Base	Base	2	MDP 15mm	568x255x15
04	Prateleira Móvel	Mobile Shelf	Estante Mobile	4	MDP 15mm	568x250x15
05	Rodapé	Footer	Pie	1	MDP 15mm	568x70x15
06	Costa	Back	Revés	2	Chapa Dura 3mm	1520x290x3



REF	DESCRIÇÃO	QTD
A	 8x30mm	04
B	 34x7mm Parafuso Minifix	08
C	 15x12mm Tambor Minifix	08
D	 14x8x5mm Suporte Prateleira 5x8 c/ Estria	16
E	 22x3mm Prego 10x10	42
F	 14x4mm Sapata Deslizadora	04
G	 Adesivo Tapa Furo	04
H	 Perfil I 1492mm	01

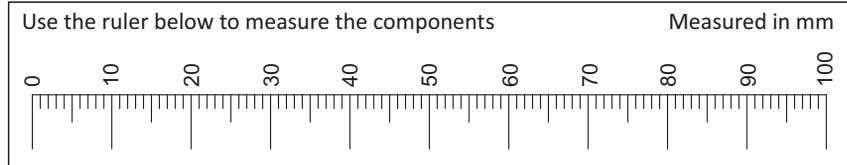

Revisão: 00
Data: 18/07/2018

