

BN-3614



Instruções de Montagem Assembly Instructions Instrucciones de Armado

Accesse Vídeos de Montagens
Access Mounting Videos
Acceder a los Vídeos de Montaje
www.tecnomobili.ind.br

tecnomobili
Estrada RSC 453, Km s/n° | Garibaldi | RS
CEP: 95720-000 | Fone / Fax: 54.3464.2050
sac@moveisvideira.com.br

Notas Especiais:

01 -Examine completamente todas as peças do móvel antes de começar o trabalho.

02 -Recomenda-se montar o móvel conforme este Manual de Montagem.

03 -É de responsabilidade do montador seguir as instruções do Manual de Montagem, que são fundamentais para garantir a estrutura do móvel.

04 -Para limpeza, utilizar somente pano úmido e sabão neutro.

Special notes:

01 -Check all parts of the unit thoroughly before starting work.

02 -It is recommended to assemble the furniture according to this Installation Manual.

03 -It is the responsibility of the assembler to follow the instructions in the Assembly Manual, which are essential to ensure the structure of the furniture.

04 -For cleaning use only damp cloth and neutral soap.

Notas especiales:

01 -Examine completamente todas las piezas del mueble antes de iniciar el trabajo.

02 -Se recomienda montar el mueble conforme el Manual de Ensamblaje.

03 -Es de responsabilidad del montador seguir las instrucciones del Manual de Ensamblaje, que son fundamentales para garantizar la estructura del mueble.

04 -Para limpieza solamente usar trapo húmedo y jabón neutro.

Guarante certificate:

The guarantee of products manufactured by Móveis Videira LTDA covers any defects / manufacturing defects, within the period established by the Consumer Protection Code, in its Article 26, II, which provides for a legal guarantee of ninety (90) days.



Cód	DESCRIÇÃO	DESCRIPTION	DESCRIPCION	QTD	RAW MATERIAL	DIMENSION	CÓD
01	Painel Espelho	Mirror Panel	Panel Espejo	1	MDP 15mm	668x600x15mm	903614
02	Prateleira	Shelf	Estante	2	MDP 15mm	246x126x15mm	203608
03	Aplik	Aplik	Aplik	4	MDP 15mm	598x20x15mm	853614
04	Suporte Painel	Panel Support	Soporte Panel	4	MDP 15mm	450x50x15mm	9795

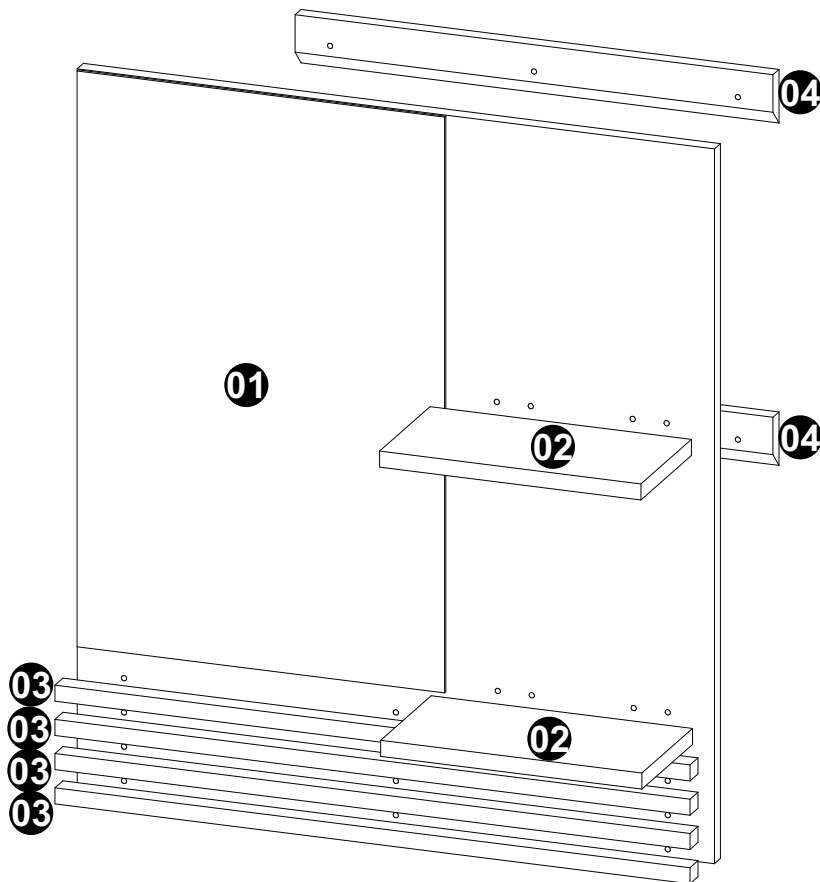

TAMANHO REAL - TAMANO VERDADERO - REAL SIZE

REF	DESCRIÇÃO	QTDCÓD
A	 Cavilha 5 x 30mm	04 3880
B	 3,5 x 40mm CC	04 8115
C	 Parafuso 4 x 25mm CC	06 9511
D	 Parafuso 5 x 60mm CC	04 1618
E	 Parafuso 3,5 x 30mm CF	12 5753

ILUSTRAÇÃO - ILUSTRACION - ILLUSTRATION

REF	DESCRIÇÃO	QTDCÓD
F	 40x8mm Bucha 8mm	04 5623

Ferramentas | Tools | Herramientas

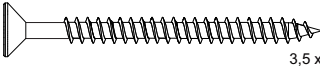
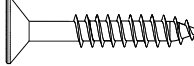
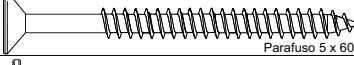
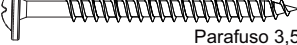
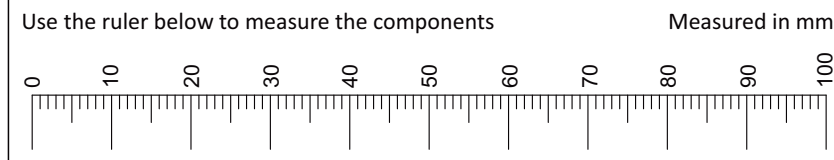
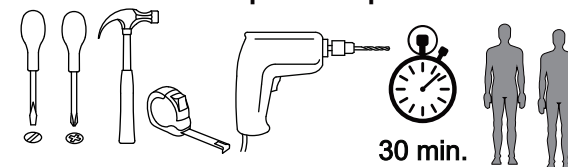

Revisão: 01
Data: 28/06/2023

