

BN-3645

Instruções de Montagem Assembly Instructions Instrucciones de Armado

Acesse Vídeos de Montagens
Access Mounting Videos
Acceder a los Vídeos de Montaje
www.tecnomobili.ind.br



tecnomobili

Estrada RSC 453, Km s/n° | Garibaldi | RS
CEP: 95720-000 | Fone / Fax: 54.3464.2050
sac@moveisvideira.com.br

Lista de Peças / List of pieces / Lista de piezas

TAMANHO REAL - TAMANHO VERDADEIRO - REAL SIZE

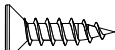
CóD	DESCRIÇÃO	DESCRIPTION	DESCRIPCIÓN	QTD	RAW MATERIAL	DIMENSION	CÓD
01	Lateral Esquerda Nicho	Nicho Right Side	Lateral Izquierda Nicho	1	MDP 15mm	600x126x15mm	313645
02	Lateral Nicho	Nicho Side	Lateral Nicho	1	MDP 15mm	600x126x15mm	303645
03	Tampo Base Nicho	Nicho Base Top	Tapa Base Nicho	2	MDP 15mm	220x126x15mm	713609
04	Painel Espelho	Mirror Panel	Panel Espejo	1	MDP 15mm	800x600x15mm	903645
05	Suporte Painel	Panel Support	Suporte Panel	4	MDP 15mm	450x50x15mm	9795
06	Prateleira Nicho	Nicho Shelf	Estante Nicho	2	MDP 15mm	220x110x15mm	203645
07	Porta	Door	Puerta	1	MDP 15mm	562x214x15mm	63645

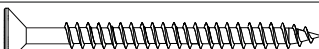
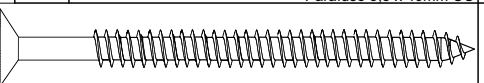
REF	DESCRIÇÃO	QTD	CÓD
A	 Parafuso 3,5 x 14mm CC	08	3639
B	 Parafuso 4 x 25mm CC	06	9511
C	 Parafuso 3,5 x 40mm CC	04	8115
D	 Parafuso 5 x 60mm CC	04	1618

Notas Especiais:

01 -Examine completamente todas as peças do móvel antes de começar o trabalho.

02 -Recomenda-se montar o móvel conforme este Manual de Montagem.

03 -É de responsabilidade do montador seguir as instruções do Manual de Montagem, que são fundamentais para garantir a estrutura do móvel.

04 -Para limpeza, utilizar somente pano úmido e sabão neutro.

Special notes:

01 -Check all parts of the unit thoroughly before starting work.

02 -It is recommended to assemble the furniture according to this Installation Manual.

03 -It is the responsibility of the assembler to follow the instructions in the Assembly Manual, which are essential to ensure the structure of the furniture.

04 -For cleaning use only damp cloth and neutral soap.

Notas especiales:

01 -Examine completamente todas las piezas del mueble antes de iniciar el trabajo.

02 -Se recomienda montar el mueble conforme el Manual de Ensamblaje.

03 -Es de responsabilidad del montador seguir las instrucciones del Manual de Ensamblaje, que son fundamentales para garantizar la estructura del mueble.

04 -Para limpieza solamente usar trapo húmedo y jabón neutro.

Guarante certificate:

The guarantee of products manufactured by Móveis Videira LTDA covers any defects / manufacturing defects, within the period established by the Consumer Protection Code, in its Article 26, II, which provides for a legal guarantee of ninety (90) days.







ILUSTRAÇÃO - ILUSTRACION - ILLUSTRATION

REF	DESCRIÇÃO	QTD	CÓD
E	 Cavilha 5 x 30mm	08	3880
F	 40x8mm Bucha 8mm	04	5623
G	 Adesivo Tapa Furo	04	
H	 34x7mm Parafuso minifix	04	3771
I	 15x12mm Tambor minifix	04	9516
J	 Dobradiça Reta Caneco 26 Calço Nº 1	02	3614
K	 14x8x5mm Suporte Prateleira 5x8 c/ estria	08	3748

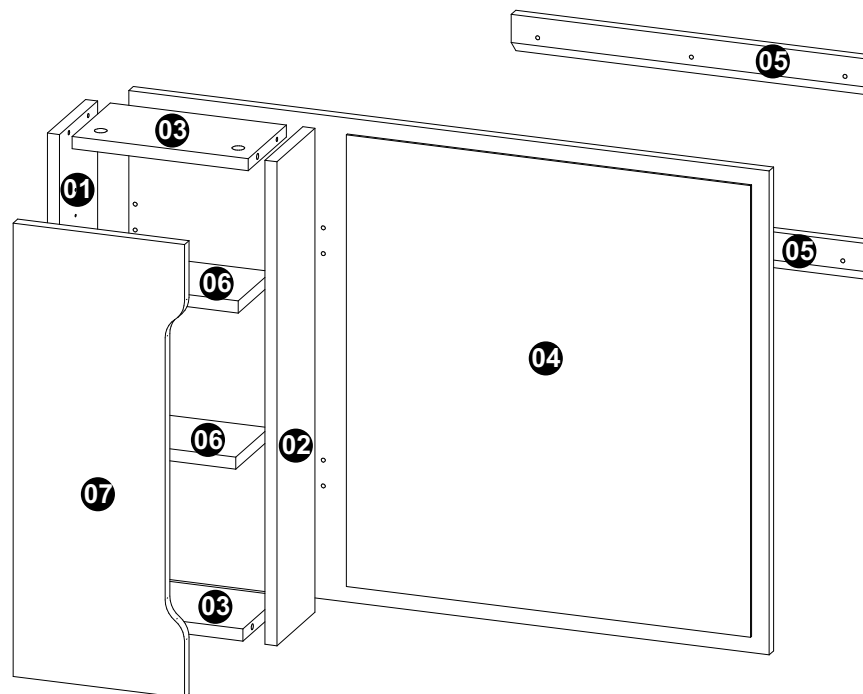
Ferramentas | Tools | Herramientas

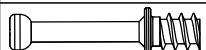

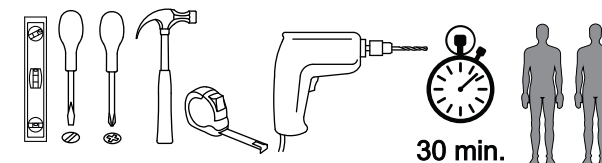
30 min.

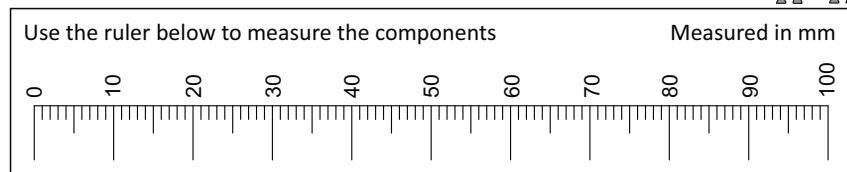

Revisão: 00
Data: 19/06/2023

